A N N A L E S
UNIVERSITATIS MARIAE CURIE-SKŁODOWSKA
LUBLIN – POLONIA

VOL. LIX, 2

SECTIO H

2025

RIČARDAS MILERIS

ricardas.mileris@ktu.lt

Kaunas University of Technology

K. Donelaičiost. 73, Kaunas, Lithuania

ORCID ID: <https://orcid.org/0009-0000-6936-1267>

*Post-Pandemic Business Culture of Rising Prices: The Impact of
Inflationary Pricing Decisions on Profit and Purchasing Power*

Keywords: consumption; inflation; profit; statistical modelling

JEL: C15; C53; E31; H63; L21

How to quote this paper: Mileris, R. (2025). Post-Pandemic Business Culture of Rising Prices: The Impact of Inflationary Pricing Decisions on Profit and Purchasing Power. *Annales Universitatis Mariae Curie-Skłodowska, sectio H – Oeconomia*, 59(2), 121–141.

Abstract

Theoretical background: The rise of inflation commonly awakes the interest of economists that are the most competent to reveal the root causes of this phenomenon and explain the expected economic consequences. The inflation causing behavior of economic participants at microeconomic level differs significantly, but it is expected from economists to explain the consistent patterns of all interests generating economic processes at macro level.

Purpose of the article: The research aims to estimate how the inflation influenced the profits of enterprises and purchasing power of consumers in Lithuania during the post-pandemic period.

Research methods: The system dynamics modelling, correlation and regression, descriptive statistics, time-series and elasticity analysis methods were applied in empirical research.

Main findings: The excess profits and increment of profitability were typical for most economic activities during the post-pandemic period. The general decline in consumer prices of 5% or 10% could be reasonable in the event of higher competition and market power of customers. The control of value added of entrepreneurs allowed reach several times higher net profits compared to the growth of real purchasing power of employed population. The aggregated financial and economic data analysis indicated signs that pricing policies of higher prices and higher profits became the common component of post-pandemic business culture under the inelastic demand in the domestic market of products and services.

Introduction

Inflation is widely analyzed in scientific literature for many years since the first economic theories appeared, but in European Union, and especially in countries of European Monetary Union (EMU) the significant inflation problems were avoided in recent decades, so the interest in inflation was quite diminished, until suddenly the COVID-19 pandemic began and subsequently the inflation phenomenon exposed. When due to the immeasurable efforts of governments, global pharmacy corporations, medical and legal institutions the spread of coronavirus was stopped, the population of European Union faced the new economic problem of price instability. The consumers began spending more money on the same purchases, their savings lost the significant part of initial value, the business enterprises had to review their budgets and faced the more complicated financial planning and finance management processes, the governments found it necessary to have more public spending as market prices in general rose significantly, and the central banks had to select the appropriate monetary policy measures striving to increase the price stability.

As a threat like others, at the same time inflation for some economic elements can unclothe the possibilities and benefits. When the customers suffer the growing expenses, the opposite direction money flows can generate profits. If the demand elasticity in consumer markets is low, the benefits of price increment outweigh the loss of revenue caused by the slight shrink in demand. Often in the economic environments of high inflation the demand can be inelastic, when the growth of prices induces the growth of personal income of population. Under these conditions, the customers experience the growth of real consumption, but they become disorientated in continuously growing prices and the reasonable purchasing decisions become complicated. The growing short-term macroeconomic indicators, personal income, and prices motivate borrowing. Businesses are targeted towards the growing money supply in the markets and customers' inability to make rational decisions. The business costs also grow, and the companies often aim to increase the prices more than real necessities are now when making the pricing decisions. That stimulates continuous inflation.

So, the objective of this research is to estimate the general pricing behavior of business enterprises by analyzing the aggregated financial data and answer the questions, how inflation influences the profits of enterprises and purchasing power of consumers during the post-pandemic period.

Literature review

Recently, the advanced, emerging, and developing economies experienced the growth of inflation since 2021, and the peak was reached in 2022. The economists widely analyze different aspects of this price shock, primarily striving to explain

the root causes. Prabheesh et al. (2024) claimed that the spike in inflation directly related to the expansionary monetary policies during the COVID-19 pandemic. Beck (2023) pointed out that the COVID-19 shock had a much stronger impact on the euro area than the global financial crisis in 2009. The exceptions are the Baltic states, where the effects of the global financial crisis were especially dire, and the inflation in 2022 was exclusively high.

Chen and Kim (2024) highlighted three groups of factors determining recent global inflation dynamics: a combination of cost-push and demand-pull factors, fiscal stimulus packages of the pandemic crisis, and various unforeseen events. Hong et al. (2025) accentuated the expectations of customers as important factors of continuous inflation, that can drive prices upwards if the population is not susceptible to saving. According to Shaw (2024), consumers form inflation expectations based on their observations on the daily prices and found that changes in the prices of household-level goods play a significant role in changing the inflation expectations.

Analyzing the domestic inflationary pressures, Matamoros (2024) found that post-pandemic profits of firms rose to historically high levels, surpassing the cost-price increments. Enterprises having the high market power and acting as price-setters have not only transferred the cost increments to prices but also increased their markups pushing up inflation even further. Gallo and Rochon (2024) similarly argued that businesses became able to maintain their profit margins by passing on their higher costs to consumers and showed that the average markup became significantly above its pre-pandemic level. Lear (2024) suggested that profit-push was the most important factor of inflation in 2021–2022, when the unit profits or markups increased significantly, and these increments fractionally were noticeable components of post-pandemic prices. As the increment of prices became a common practice of post-pandemic businesses it can be considered as a new business culture.

In general, Oh et al. (2024) conceptualized two concepts of a culture. The static notion delineates culture as one specific point of environment observation in the group of people. The dynamic concept depicts a collective being of people that negotiate in their interactions with external and internal environments along with formal and informal institutions. The interactions with both endogenous and exogenous forces can engender changes of collective opinion between concerned parties either consciously or unconsciously. Ardichvili et al. (2012) elaborated that cultures in business organizations include formal and informal systems, processes, and interactions among the organizational members and between organization and various outside stakeholders. The formal component of business culture consists of structures, policies, rewards, personnel socialization and decision-making processes, while the informal component includes the tacit norms and values shared by members of the organization. According to Chin et al. (2023), the culture of institutions characterizes their shared beliefs, assumptions, and values operating at multiple mutually nested levels, ranging from the individuals' attitudes towards local situations to the overall economic systems at national and international levels.

Ardichvili et al. (2012) emphasized a modern ethical business culture as a sense of responsibility and accountability in business-related actions, when the managers model their behaviors considering the demands of others. Recently, in response to the sustainable development goals of United Nations for fighting inequality, poverty, environmental degradation, and peace, an increasing number of enterprises became oriented towards the ecosystem-based business models as ways for harmonizing the economic growth with social and environmental needs, where a wider range of stakeholders act achieving the balance of profit, people, and planet (Chin et al., 2023). Asproumouros (2024) maintained that the development of modern economy should be understood as economic growth with qualitative and structural change, via ongoing innovation and rising labor productivity, and delivering rising consumption per capita extending to the mass of society's members. Yan et al. (2024) supplement this idea with modern business ethics standards embracing social norms like cooperation, harmony, tolerance, and compromise, rejecting a winner-take-all mind-set, and nurturing positive long-term relationships with communities, and implying that people must act appropriately and reciprocally to maintain social standing.

Grachev and Izumov (2004) suggested the methodology of cross-cultural analysis investigating differences in value orientation of business managers based on their responses to a set of questions covering nine areas of organizational and societal behavior models: hierarchy and power distance, societal collectivism, family collectivism, risk and uncertainty avoidance, assertiveness, performance orientation, gender egalitarianism, humane orientation, and future orientation. In modern ethical business culture, the humane orientation is expected to obtain high values, where an organization encourages individuals to be generous, friendly, fair, caring, altruistic, and kind to others, together with societal collectivism, where organizations are encouraged through societal institutional norms to distribute power and resources more equally.

However, during the post-pandemic period of high inflation the signs of the contrary predatory entrepreneurship became noticeable, which is characterized as ruthless exploitation of available resources with little concern for the welfare of customers, business partners, and society. As the highest inflation in 2022 was in ex-communist countries of European Union, this can be logically interrelated with the arguments of Brewster and Bennett (2010), that these countries have a specific variety of capitalism, called the transitioning economies, adopting purer forms of neo-liberalism, while the wealthier countries in the region are more likely to infuse aspects of the European social model. Kozarzewski and Bałtowski (2022) characterized the liberal market capitalism as the economy which functions based on the competition mechanism, with system beneficiaries determined by the market. Fritsch (2023) concerned the liberal commercial societies with the moral fallout of the great merchants and manufacturers, increasing the risk for society's moral embeddedness, material progress and social cohesion. Barber et al. (2023) adopted the neutralization theory to explain the change of business culture and justification of unethical behaviors. Neutralization processes encompass a breakdown of morals, allowing

an individual to be entangled in unethical acts without concern. Salespeople use neutralization techniques to justify ethical intentions when they exhibit lower levels of organizational commitment, higher levels of role ambiguity, and lower levels of relationship orientation. The purposely increased market power of firms under these circumstances in the research of Matamoros (2024) was called the “price gouging” or “greedflation”. When neutralization occurs, organizational behavior takes the form of shareholders pressure towards a profit-maximization mission, where unethical sales-related behaviors negatively impact customer value and relationship quality. These actions are included into the shifted business strategy, repositioning and transforming the organization, which consists of integrated decisions, actions or plans that help to achieve target goals to maximize the profits (Zapletalová, 2023). The higher the business strategy aggressiveness is, the more likely firms will adapt to changes in the external environment (Zhang et al., 2024). Because business culture must be compatible with the requirements of the environment, when designing the new culture, change agents should bear in mind all the externalities and internalities that could be used as a source for benefits (Zurkinden, 2022).

The research of Gallo and Rochon (2024) offered a post-Keynesian explanation at the microeconomic and macroeconomic levels of the inflation shock during the post-pandemic period. First, to ensure the stable profit margins the initial pandemic cost-push shock was passed to consumers through higher prices. But in a second phase, some firms, particularly in more highly concentrated and systemically significant sectors, began to benefit from the post-pandemic permissive pricing environment to increase their price mark-ups, leading to temporary profit-fuelled inflation following the previous cost-push shock. With reference to Błoński and Witek (2019), the problems in economy begin when shortages in consumption due to inflation cause the social exclusion of significant part of society members, while over-consumption becomes the main purpose of life for another part of inflation promoting individuals.

Research methods

The main hypothesis of empirical research is the following: the business enterprises independently formed the post-pandemic business culture to increase the prices continuously, maximizing the profits and reducing the importance of price competition. The research structure consists of the following parts. Firstly, the trends and differences in inflation values were compared in the European Union (EU-27) countries. Secondly, the dynamics of final consumption expenditure and real production outputs were analyzed to find the common patterns in inflation differences. Thirdly, the motivation to exclude the Lithuanian economy from the EU-27 context was substantiated. Fourthly, the money supply factors of Lithuanian inflation together with production outputs and consumption expenditure were analyzed, estimating the aggregated demand elasticity. Then the aggregated profit statistics of Lithuanian en-

terprises was presented, and the system dynamics model was developed to model the hypothetical aggregated profits in different steps of general price reduction. Finally, the indices of consumers' purchasing power were calculated and compared between EU-27 countries highlighting the impact of inflation.

The set of methods applied consists of descriptive statistics, time-series statistics, correlation and regression analysis, elasticity coefficients, system dynamics modelling of economic systems, and graphical visualization of complex economic data. The statistical data was used from Eurostat, Statistics Lithuania, and Bank of Lithuania databases.

Results

After a steady low inflation economic environment, the European Union faced the sudden post-pandemic inflation shock. Analyzing the period of 2014–2023, the highest inflation in European Union was in 2022 when it reached 9.2% and until 2023 it declined to 6.4%. The leaders of inflation in 2022 were three Baltic countries: Estonia (19.4%), Lithuania (18.9%), and Latvia (17.2%). The other countries having the inflation rate higher than EU-27 average (9.2%) were Hungary, Czechia, Poland, Bulgaria, Slovakia, Romania, the Netherlands, Croatia, Belgium, Greece, and Slovenia (Figure 1).

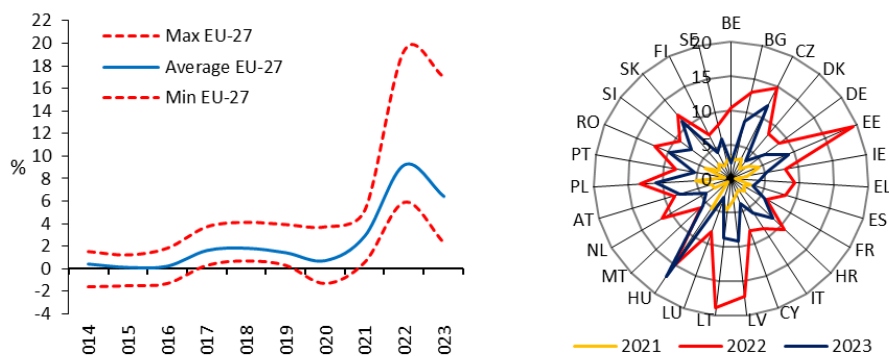

Figure 1. Inflation rate in the European Union 2014–2023 (%)

Source: Eurostat.

The growing prices of consumer goods and services significantly reduced the purchasing power of the euro and national currencies of non-EMU countries in the European Union. The final consumption expenditure at market prices of EU-27 households in 2020–2023 increased by 30.9% (from EUR 6.8 to EUR 8.9 trillion), while the real consumption during this period grew only by 9.7%. In 2023 the real consumption in the European Union almost stopped growing (the growth compared to 2022 was only 0.47%), but the inflation required customers to spend 7.12% more money on almost the same quantities of goods and services. The consolidated GDP at market prices of

EU-27 countries in 2020–2023 increased by 26.6%, when the real production output growth of three years pandemic and post-pandemic period was 10.5%. The real output growth in 2023 was only 0.43% what indicates the evident negative consequences of high inflation, limiting the abilities of customers to increase their standards of living by getting the higher real consumption value from the sellers when paying significantly more money for their products and services. However, the value added which is the difference between market value of a product or service, and the sum value of its constituents (raw materials, energy, wages of employees, etc.) in 2020–2023 increased by 27.9%, and in the period of restrained real economic growth of EU-27 in 2022–2023 it grew by 7.18% (Figure 2). It can be hypothesized that the pandemic-related public debt growth increasing the money supply during the economic slowdown in 2020 induced the inflation, and during the post-pandemic period the business culture has been formed to raise prices more than the business costs grow, aiming to maximize the profits under the conditions when the customers mistakenly got the persuasion that inflation is unavoidable, uncontrollable, and spending more money for the same value obtained from the sellers is currently the usual practice.

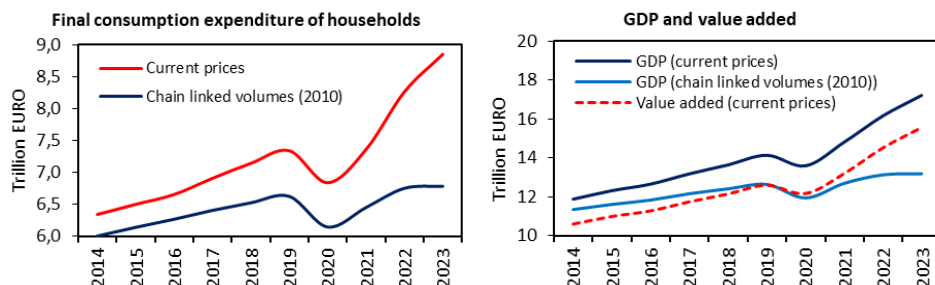

Figure 2. Final consumption expenditure of households, GDP and value added in the European Union 2014–2023

Source: Eurostat.

In Figure 3, the statistical interrelations of inflation in EU-27 countries and other four macroeconomic indicators were visualized. The period of 2020–2023 was selected to compare the growth rates of consumption expenditure of households and the growth rates of real GDP, together with GDP per capita, net earnings of 1 person, and inflation of the year 2022. The analysis results allow to affirm that high inflation was typical for EU-27 countries having the relatively low real GDP growth and high consumption expenditure of households at market prices. The relatively low GDP per capita and the average net earnings of 1 person are also typical for these countries. This can be explained that highly developed economies are more resistant to inflation when the real production output generates significant part of earnings in the economy instead of borrowed money, and conversely, the limited production output and increased money supply leads to inflation shock.

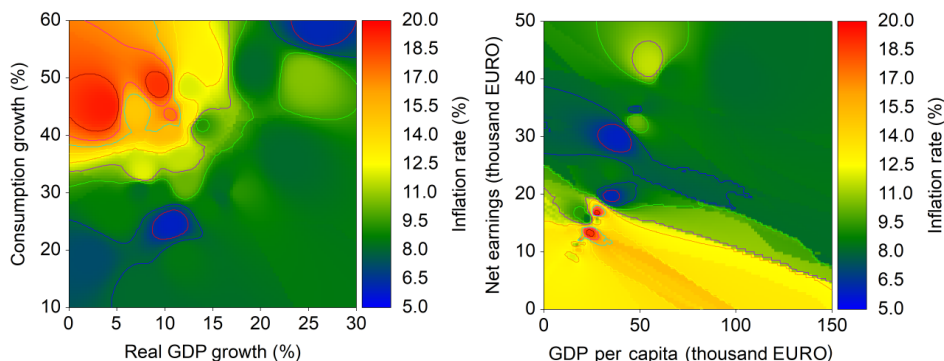

Figure 3. Statistical interrelations of final consumption expenditure of household growth, real GDP growth, net earnings of one person, GDP per capita, and inflation in the European Union

Source: Eurostat.

The increase in money supply notably more than real production output allows businesses control the value added demonstrating their market power against customers. The profit maximization principle in the inflationary business environment takes precedence over the necessity to cover the increased costs in the value creation chain. Increasing the profits as the financial benefits of shareholders, the consumer price growth worsens the living conditions of lower income inhabitants in less developed economies.

The motivation to analyze Lithuania as a case study is based on the post-pandemic situation where the inflation was one of the highest in European Union (18.9% in 2022 and 8.7% in 2023). The negative consequences of inflation shock are evident. Compared to previous year in 2023 the Lithuanian real GDP grew only by 0.34%, the real final consumption of households declined by 0.40%, while the consumption expenditures at current prices grew by 8.54%. The exports of goods and services declined by 3.60% what was caused by the loss of competitiveness due to higher costs and prices of Lithuanian businesses having the lower market power in international markets. In average 21.3% of EU-27 inhabitants were at risk of poverty or social exclusion, while in Lithuania this proportion was 24.3% (Figure 4).

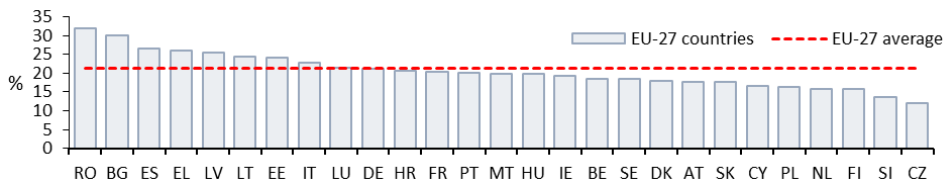

Figure 4. Proportion of inhabitants at risk of poverty or social exclusion in the European Union (2023)

Source: Eurostat.

The government of Lithuania at the beginning of 2025 initiated the establishment of Food Council aiming to advise how to control and reduce the food prices suspecting the surplus profits of manufacturers and traders. The concern was related to the risk that about ¼ of population having low income will meet the deterioration of living quality being unable to satisfy their basic needs. The harmonized index of consumer prices (HICP) for food in Lithuania reached the value of 169.6% in 2024M12 (2015 = 100%). The higher values were only in Poland (170.6%), Bulgaria (174.5%), and Hungary (205.8%). The similar situation was in Latvia and Estonia where HICP for food were 169.4% and 168.9% (Figure 5). So, it can be concluded, that the nearest EU-27 countries to Lithuania (Poland, Latvia, and Estonia) had the similar growth of food prices taking the 3–6 places in the list of EU-27 countries, when the median HICP for food in EU-27 was 143.4% and the least value of 112.2% was in Ireland.

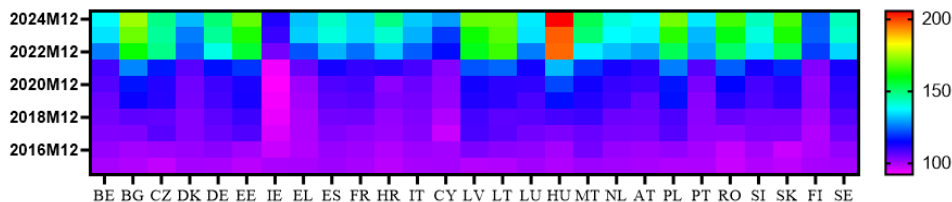

Figure 5. Food HICP in the European Union 2015M12–2024M12 (2015 = 100%)

Source: Eurostat.

The money supply in Lithuanian economy is constantly growing. The loan portfolio of Lithuanian deposit-taking monetary financial institutions (MFIs) in 2020–2024 increased by 48.4% from EUR 18.6 to EUR 27.6 billion (Figure 6).

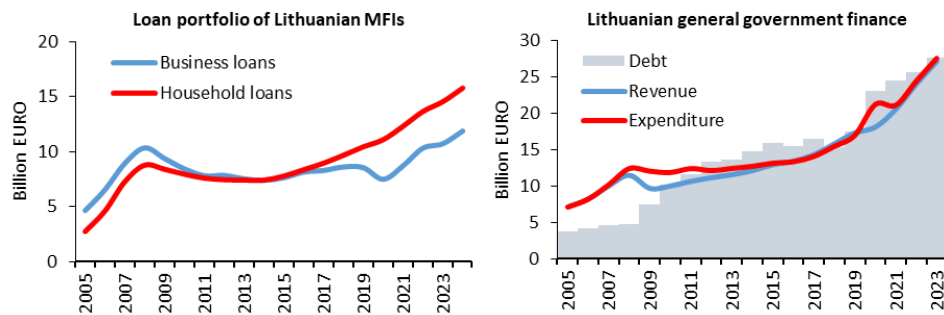

Figure 6. Loan portfolio of Lithuanian MFIs, Lithuanian general government’s total revenue, expenditure and consolidated gross debt

Source: Bank of Lithuania and Eurostat.

The consolidated gross debt of Lithuanian general government during the period of 2019–2023 increased by 57.2% and reached EUR 27.6 billion. The pandemic budget deficit (2020) of EUR -3.2 billion was reduced to the range of EUR [-642.7; -476.6] million in 2021–2023, however, the high inflation did not allow ensure the balanced budget because the expenditures surpassed the revenue during the post-pandemic years (Figure 6). The consequences of inflation will have the negative impact even on 2025 year’s budget where the planned revenue of Lithuanian Ministry of Finance is EUR 17.98 billion, the expenditure is EUR 23.1 billion, and the budget deficit is EUR -5.12 billion, which is the highest deficit in more than three decades.

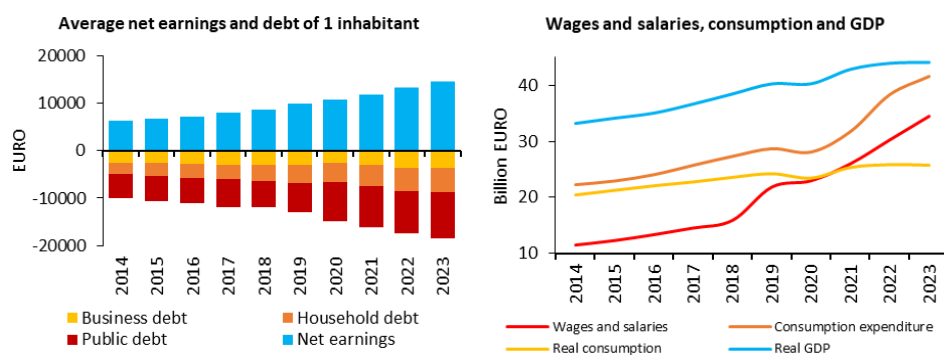

Figure 7. Average annual net earnings and indebtedness of one Lithuanian inhabitant, wages and salaries, consumption expenditure, and real GDP of Lithuania in 2014–2023

Source: Bank of Lithuania and Eurostat.

The aggregated business, household, and public debt of one Lithuanian inhabitant during the period of 2019–2023 increased by 42.1% to EUR 18,413, while the annual net earnings grew by 48.6% to EUR 14,557. The net earnings to debt ratio increased from 75.6% to 79.1%, what indicates that inhabitants benefited from higher indebtedness by earning more money. The wages and salaries grew by 57.5% together with growing final consumption expenditure of households (+45.3%). However, the real consumption in 4 years increased only by 6.2%, which is in average by 1.55% yearly (Figure 7).

The correlation analysis (Table 1) has shown that the final consumption expenditure of households (FCE) directly correlates (0.968) with wages and salaries (WAS), whereas the real consumption (RCO) has the strongest direct correlation (0.985) with real GDP. So, it is evident that the rapid increment of wages without real production output growth stimulates inflation, loss of currency value, and has weak positive impact on real consumption.

Table 1. Pearson's correlation matrix (period 2014–2023)

		WAS	FCE	RCO	GDP
WAS	Pearson Correlation	1	.968**	.924**	.962**
	Sig. (2-tailed)		.000	.000	.000
FCE	Pearson Correlation	.968**	1	.907**	.921**
	Sig. (2-tailed)	.000		.000	.000
RCO	Pearson Correlation	.924**	.907**	1	.985**
	Sig. (2-tailed)	.000	.000		.000
GDP	Pearson Correlation	.962**	.921**	.985**	1
	Sig. (2-tailed)	.000	.000	.000	

** correlation is significant at the 0.01 level (2-tailed)

Source: Author's own study.

Statistical analysis allows to affirm that pandemic and post-pandemic expansion of debts and limited production output inevitably led to inflation. The interrupted supply chains during the pandemic reduced the supply of some raw or final products, what keeping the high demand of goods and services due to enlarged money supply induced the price growth. Aiming to keep the purchasing power of inhabitants the businesses and public sector began to increase the salaries of employees thus keeping the inflation. The growth in costs is an objective reason for increasing the prices of goods and services. The pandemic has ended, the value creation chains mostly recovered their initial conditions, but the inflation continues. The upturn of revenue in business enterprises continues when the real consumption growth is very moderate. So, the following question is: where does the money flow? Perhaps the post-pandemic business culture has been formed to increase the prices generally, reducing the role of price as a competitive measure? Maybe the inflationary environment allowed the sellers to obtain higher market power against customers? The analysis of profit dynamics should answer these questions.

The net profit of non-financial sectors during the 5 years period of 2018–2023 in Lithuania increased by 129.5% from EUR 4.4 to EUR 10.1 billion. The commercial banks in 2023 compared to the previous year due to the growth of interest rates increased their net profit by 100.7%. So, the inflation doubled the profit of banks in one year which is included in financial costs of many business enterprises. The non-life insurance services also are the common participants in value creation chains that in 5 years increased the net profit by 205.2%.

The other root sectors having the significant impact on costs in value creation chains are the energy suppliers, information and communication services, mining, water supply and waste management. The panel data analysis in Figure 8 shows how the net profit changed in these and other sectors. The energy price shock in 2022 increased the net profit of electricity and gas suppliers by 71.1%, the information and communication companies in 2021–2023 observed the increment of their net profit by 192.7%. The mining enterprises during the 5-year period increased the net profit by 80.7%, and the water suppliers and waste managers by 125.3%.

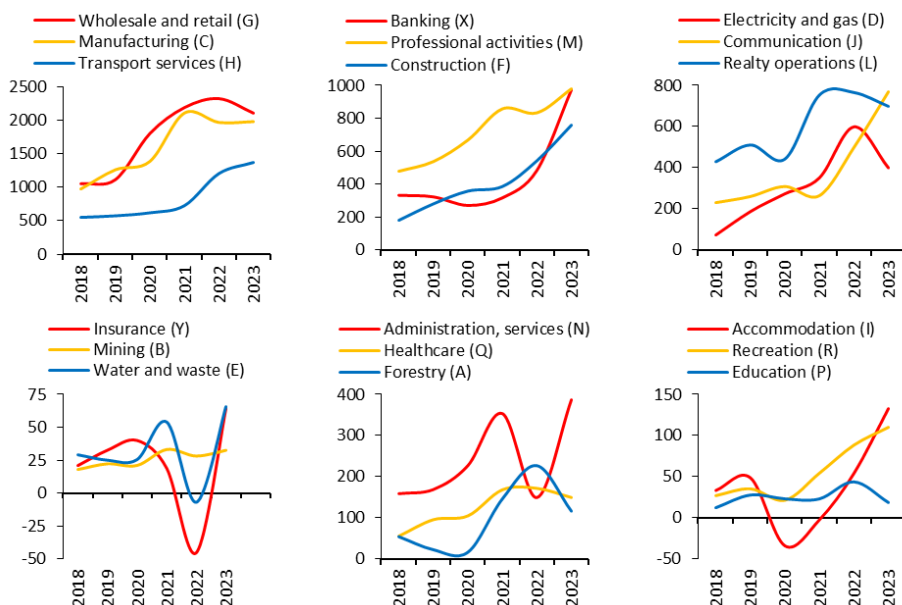

Figure 8. Net profit of economic activity sectors in Lithuania 2018–2023 (million EUR)

Source: Statistics Lithuania.

The Lithuanian manufacturers mostly benefited in 2021 when the net profit rose by 51.6%, while during the following post-pandemic years the slight decline of profit was observed. In the wholesale and retail sector the period of significantly growing profit was 2019–2022 when the increment rate had the value of 89.4%. The analyzed period of 2018–2023 was highly profitable for transportation services (+148.4%), construction (+317.1%) and most other sectors of economic activities (Figure 8).

The net profit margin during the pandemic and post-pandemic years significantly increased in almost all sectors (Figure 9). The most profitable were realty operations (L), professional, scientific, and technical activities (M), and forestry sectors where the net profitability exceeded values of 20%. The inflationary environment allowed even the loss-making sectors of water supply and waste management (E), and accommodation services (I) reach the highest net profitability in 2023.

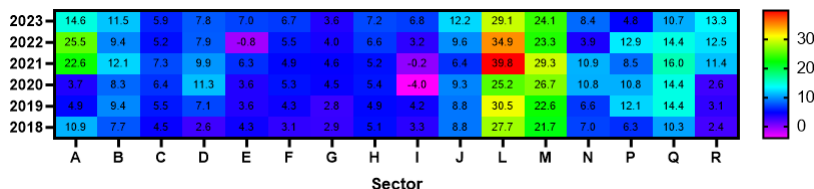

Figure 9. Net profit margin of economic activity sectors in Lithuania 2018–2023 (%)

Source: Statistics Lithuania.

The aggregated demand elasticity coefficients (E_d) were calculated in Table 2 dividing the percentage change in demand (ΔQ_d (%)) by the percentage change in prices (ΔP (%)). The aggregated demand change is related to the real consumption dynamics according to final consumption expenditures of households at comparative prices in Lithuanian market and the general change of prices is the inflation rate.

Table 2. Aggregated demand elasticity in Lithuanian market of products and services (2015–2023)

Year	2015	2016	2017	2018	2019	2020	2021	2022	2023
ΔP (%)	-0.70	0.70	3.70	2.50	2.20	1.10	4.60	18.90	8.70
ΔQ_d (%)	4.18	3.85	3.13	3.62	2.78	-3.24	8.14	1.99	-0.40
E_d	-5.97	5.50	0.85	1.45	1.26	-2.94	1.77	0.11	-0.05
ΔR (%)	1.39	2.39	11.57	8.92	7.20	-1.15	23.81	27.61	-0.20

Source: Author's own study based on Eurostat and Statistics Lithuania data.

The analyzed 2015–2023 years can be divided into five periods. The first period of 2015–2016 is the partition of decade with approximate zero inflation and the real consumption growth based on real production outputs. The growth of the economy allows society to benefit from produced goods when the increased consumption expenditure means the higher value for customers. The second period of 2017–2019 reflects the attempts of sellers to increase prices (inflation rate is in range 2.2–3.7%), the growth of demand becomes slightly slowed, but the annual change rate of aggregated revenue of enterprises (ΔR (%)) shifted upwards due to growing prices and demand (Table 2). The third period is the beginning of the COVID-19 pandemic (2020) where demand elasticity coefficient indicates the elastic demand ($E_d = -2.94$), the sellers observed the downturn of revenue, but it is determined by the loss of demand due to global lockdowns and not by the reaction of customers on prices. The fourth period (2021–2022) is the inflation shock where the increased money supply and demand with insufficient real production output growth induced the inflation. The business enterprises saw sudden growth of revenue in 2021 and one year later the price increment tendency ran up. The demand growth slowed in 2022, but the business revenue was enormous (+27.61%). Finally, the fifth period (2023), where the demand elasticity coefficient shows the adequate reaction of customers towards prices, with the declining demand and revenue of business companies, and lower inflation. This proves that the intention of customers to demonstrate higher market power before the inflation soars could reduce the general level of prices.

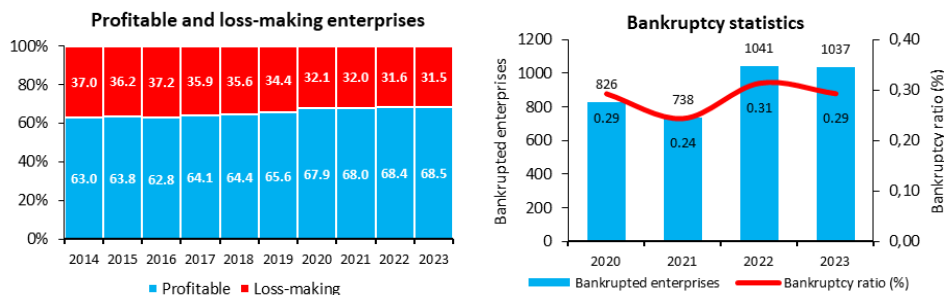

Figure 10. Profitable, loss-making, and bankrupted enterprises in Lithuania

Source: Statistics Lithuania.

The proportion of profitable enterprises in 2022–2023 became the highest over the past decade (68.4–68.5%). The bankruptcies also increased but considering the growing number of enterprises the relative bankruptcy ratio in 2023 remained the same (0.29%) as in 2020 (Figure 10). Therefore, it can be concluded that inflation in general did not cause the deterioration of enterprises’ financial condition and the growth of costs in value creation chains was redirected towards customers together with increased profit margins ensuring the financial benefits of businesses during the high inflation period.

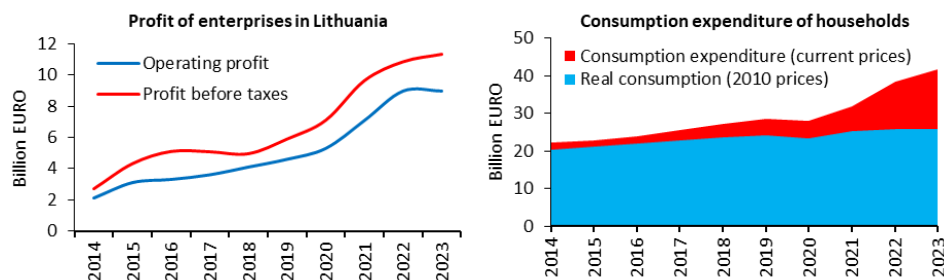

Figure 11. Aggregated profit of Lithuanian companies and final consumption expenditure of Lithuanian households in 2014–2023

Source: Statistics Lithuania and Eurostat.

The growth of aggregated operating profit and profit before taxes of Lithuanian companies during the post-pandemic period is visible in Figure 11. The growing gap between final consumption expenditures of Lithuanian households and real consumption during the same period is also evident. This can be explained with the macroeconomic notion of a stable inflation barrier. For a given quantity of real output when the competition in prices is high, the profit earners defend their share of income causing cost-push inflation, which is produced by a one-time price increase. The inflation becomes persistent if the aggregate mark-up changes. Therefore, the

following analysis aims to model the situations how the profit before taxes could be influenced by the lower prices of products and services.

The system dynamics model was developed (Figure 12) to describe mathematical interrelations between entries of aggregated income statement of all business companies in the economy and the changes of final consumption expenditure of households at current prices in case of selected general price reduction in the markets of products and services. The inputs in the model are the aggregated revenue, cost of goods sold, operating expenses, other activity results, financial and investment activity results of all companies in the economy, final consumption expenditure of households, and the simulated average percentage of price reduction in all markets of a particular country in one year.

The outputs of model are of three types. First, the model indicates the real consolidated gross profit, operating profit, and profit before taxes of all companies to control the correctness of the results and to have the comparative profit values for the modelled situations. The validation of model was implemented by testing the financial data of years 2022–2023. Secondly, the same profit types with asterisk (*) indicate the first modelled situation, where the prices of goods and services together with consumption expenditures of households are reduced by the selected percentage keeping all business costs at the same level (Scenario 1). Finally, the same profit types with two asterisks (**) indicate the expected financial results of business companies at macro-level, where the prices and expenditures of households are reduced by the selected percentage, but all the saved money is spent on additional products and services, keeping the business revenue at the same level as initial situation, and increasing the cost of goods sold (variable costs) proportionally to the growth of demand of products and services (Scenario 2). The number values in Figure 12 indicate the EUR 11,277 million of real profit before taxes in 2023 in whole Lithuanian economy, EUR 9,193.5 million of expected profit before taxes* in case of 5% reduction of prices, and the expected EUR 9702.7 million of profit before taxes** in case of producing more products and services when saved 5% of money is spent on additional goods and services that increase the variable costs in business enterprises.

The system dynamics modelling results are given in Table 3. The general change of prices (ΔP) of goods and services were modelled from -1% to -25% in 2022 and 2023. The hypothetically aggregated operating profit (OPP) and profit before taxes (PBT) were calculated for both scenarios. As in consolidated income statement of Lithuanian enterprises their net results of other, financial and investment activities were positive, the profit before taxes is higher than operating profit. However, not all companies get income from these supplementary activities, so in the modelling process it was important to ensure the main activities profitable. Due to this reason, the operating profit was listed in Table 3 together with profit before taxes.

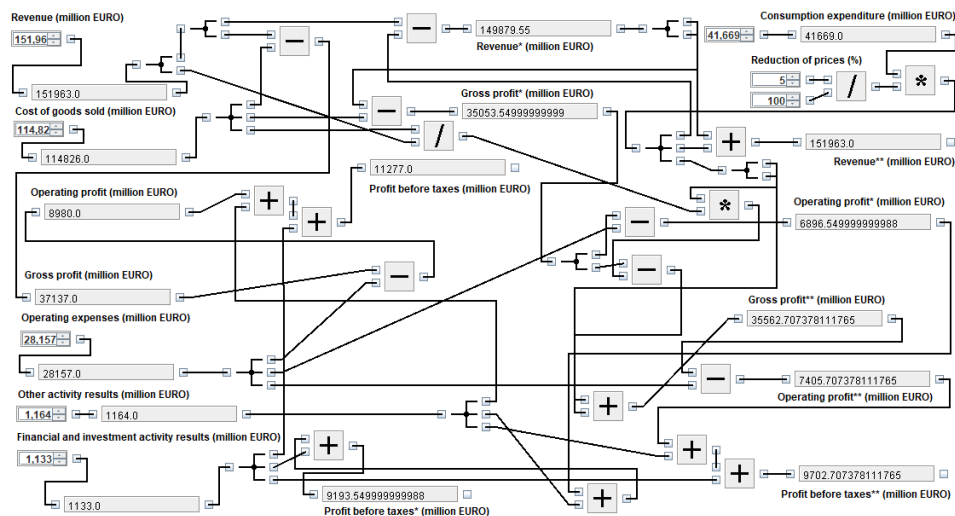

Figure 12. System dynamics model of interrelations between consumption expenditure of households and profit before taxes of business companies in the economy

Source: Author’s own study.

Table 3. System dynamics modelling results of aggregated operating profit and profit before taxes of Lithuanian companies in 2022–2023 (million EUR)

ΔP		0%	-1%	-3%	-5%	-10%	-15%	-20%	-25%
2022									
Scenario 1	OPP*	8 969	8 585	7 817	7 049	5 129	3 210	1 290	-629
	PBT*	10 789	10 405	9 637	8 869	6 949	5 030	3 110	1 191
Scenario 2	OPP**	8 969	8 672	8 079	7 487	6 005	4 522	3 040	1 558
	PBT**	10 789	10 492	9 899	9 307	7 825	6 342	4 860	3 378
2023									
Scenario 1	OPP*	8 980	8 563	7 729	6 896	4 813	2 729	646	-1 437
	PBT*	11 277	10 860	10 026	9 193	7 110	5 026	2 943	859
Scenario 2	OPP**	8 980	8 665	8 035	7 405	5 831	4 257	2 682	1 108
	PBT**	11 277	10 962	10 332	9 702	8 128	6 554	4 979	3 405

Source: Author’s own study based on Statistics Lithuania data.

The modelling has shown that in all cases the activities of Lithuanian companies is profitable if the prices decline 20%. Scenario 2 indicated when the money saved due to lower prices is spent on additional products and services, even 25% of price decline kept the businesses profitable in both years. Whereas the businesses must earn profits what is necessary for the healthy economy, and only the excess profits are socially irresponsible and reflect the insufficient competition and greedflation, the decline of 5% or 10% in general price level could be quite reasonable. In case of price reduction by 10% in 2022, the aggregated operating profit of companies in the model declined by 42.8%, the profit before taxes was lower by 35.6% (Scenario 1).

The changes in Scenario 2 were -33.0% and -27.5%. In 2023, the operating profit of Scenario 1 was lower by 46.4%, and the profit before taxes – by 37.%. The change rates of Scenario 2 were -35.1% and -27.9%, respectively (Table 3). The hypothetical dynamics of aggregated profits of Lithuanian businesses in case of 5% and 10% price reduction in whole consumer markets is shown in Figure 13.

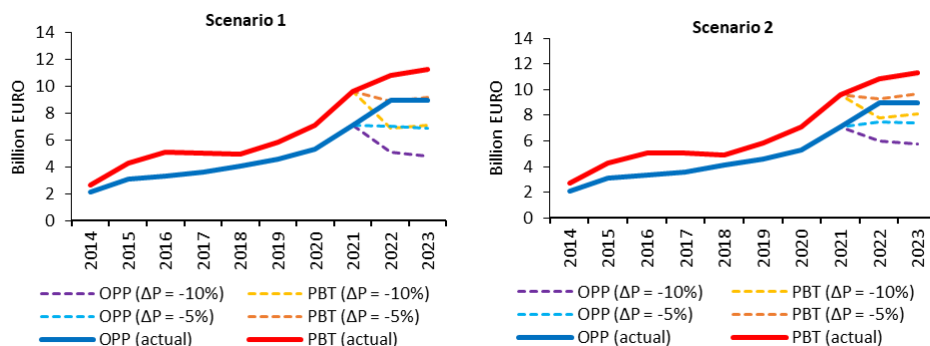

Figure 13. Scenarios of aggregated operating profit (OPP) and profit before taxes (PBT) of Lithuanian enterprises in cases of hypothetical reduction of prices (ΔP) by 5% and 10%

Source: Author’s own study.

Additionally, the linear regression models were developed in Table 4 to estimate the hypothetical marginal changes of consumer prices (ΔP) in 2022 and 2023 reaching the critical operating profit (OPP) and profit before taxes (PBT) values of zero. Expecting that saved money is spent on new purchases in domestic market (Scenario 2), ensuring the profitable activities of Lithuanian business enterprises the general price level could be reduced up to 30.3–36.4% in 2022 and 28.5–35.8% in 2023. The coefficients of determination (R^2) indicate the perfect fit of linear regression models to the data simulated by system dynamics model.

Table 4. Linear regression models and marginal hypothetical change of prices

Year	Scenario	Regression model	R ²	Critical ΔP (%)
2022	1	OPP* = 383.92 × ΔP + 8 969	1	-23.3616
2022	1	PBT* = 383.92 × ΔP + 10 789	1	-28.1022
2022	2	OPP** = 296.41 × ΔP + 8 969	1	-30.2588
2022	2	PBT** = 296.41 × ΔP + 10 789	1	-36.3989
2023	1	OPP* = 416.69 × ΔP + 8 980	1	-21.5508
2023	1	PBT* = 416.69 × ΔP + 11 277	1	-27.0633
2023	2	OPP** = 314.86 × ΔP + 8 980	1	-28.5206
2023	2	PBT** = 314.86 × ΔP + 11 277	1	-35.8159

Source: Author’s own study based on Statistics Lithuania data.

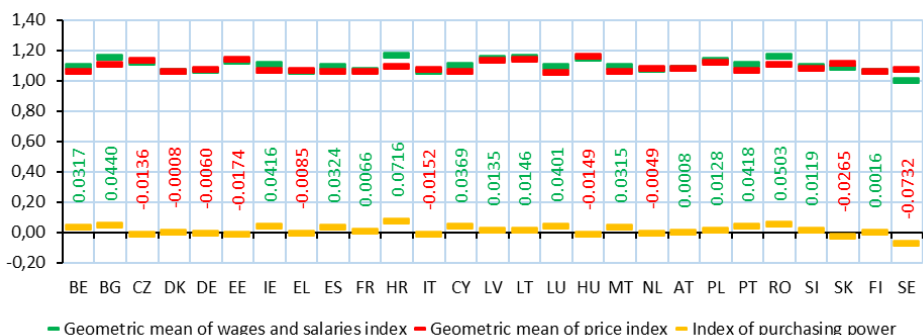

Figure 14. Average index of employed population’s purchasing power in EU-27 countries (2022–2023)

Source: Author’s own study based on EUROSTAT data.

Finally, the index of employed population’s purchasing power was calculated during the period of highest inflation in 2022–2023 for Lithuania and all other EU-27 countries (Figure 14). These indices were calculated by subtraction the geometric mean of price index from the geometric mean of wages and salaries index. The positive results indicate the growing purchasing power. Lithuanian employed population during two years of high inflation experienced the average annual growth of purchasing power by 1.46%, when the net profits of business enterprises in average grew by 9% yearly during the same period. The similar growth of real purchasing power was in Latvia (+1.35%) and Poland (+1.28%) as the neighbor countries, while the Estonian working persons suffered from 1.74% purchasing power decline. The most favorable situation was in Croatia, Romania, and Bulgaria, where the growth of wages and salaries surpassed the growth of consumer prices by 4.40–7.16%.

Conclusions

The European Union experienced the sudden inflation increase in 2022, where the leaders of inflation were three Baltic countries: Estonia, Lithuania, and Latvia. The growth of consumer prices was expected by economists in the overall European Union when the money supply was suddenly expanded by growing public debts to cover the negative economic consequences of pandemic. However, these objective reasons of inflation were supplemented by the pursuit of profit maximization in business enterprises during the period, when the markets become disorientated in prices and customers begin to conceive the continuous growth of prices as uncontrolled new reality. Especially the inflation shock was typical for the EU-27 countries with lower GDP per capita, net earnings of individuals, and real GDP growth together with sudden growth of consumption expenditure. What is widely known from Smith’s economic theory, commonly the individuals are continually exerting them-

selves to apply their capital to the most advantageous employment for themselves (that is most profitable), however, it is evident that the post-pandemic inflationary behavior of businesses has changed dramatically, demonstrating the aggressiveness towards profits.

The economic consequences of inflation shock in Lithuania were led by significantly slowed real GDP growth, decline of real final consumption of households in 2023 with continuously growing consumption expenditures, the deterioration of living conditions of low-income inhabitants, the loss of lower-cost competitive advantage in international markets and decline of exports, the highest national budget deficit in 2025. Under the conditions of wide public discussions about inadequate consumer prices, the speculations about cost-based necessity to increase prices from entrepreneurs, and their greediness from economically unprofessional consumers, the research statistically answered the questions about the typical behavior of business enterprises and customers during the first post-pandemic years.

The excess profits were observed in almost all business activities. Particularly the inflationary period was profitable for commercial banks where the net profit almost reached EUR 1 billion. The higher financial expenses increased the costs of many business enterprises, together with more expensive other primary resources and services: raw materials, energy, communication and insurance services. There is evidence to suggest that most businesses followed the actions of others to increase the prices more than the costs grew, because the further elements in the value creation chains (manufacturing, wholesale and retail, transport, construction and other sectors) also increased their profits and profitability significantly.

The simulation results of Lithuanian enterprises' aggregated profit by the developed system dynamics model have shown that the decline of consumer prices by 5% or 10% in 2022 and 2023 could ensure the business profits at almost the same levels as previous years without excess earnings. From the two modelled scenarios, the second scenario is expected to be more realistic, as the mutual benefits of price reduction, where money saved by customers could be spent on additional products and services, thus increasing the profits of businesses and getting more real consumption value for customers. However, the current business culture of higher prices and higher profits was realized to increase the benefits of shareholders. Additionally, the modelled hypothetical marginal change in general prices has shown the critical values varying in range from -36.4% to -21.6%, what indicates the real magnitude of possible price changes in case of intense competition and demonstration of customers' market power.

The slight growth of real purchasing power of 1.46% was detected in Lithuanian working population during the high inflation period when the shareholders of businesses experienced the average annual growth of net profit by 9%. So, it can be concluded that in the era of socially responsible businesses the consideration of sellers' and customers' financial equilibrium in trading transactions is not a matter in most cases. Business culture of more money for the same value is dominant. This

research endorsed the concept of greedflation simply explaining the prolonged inflation. A better understanding of the market power of customers and higher demand elasticity is highly necessary in this situation, which can reduce the inflation more effectively than central bank interest rates. The question of customers what additional value I get when paying more money is a simple measure against inflation, which leads to inflation spiral and huge debts in case of continuous increment of money supply and loss of currency value, or macroeconomic downturn, when the money supply stops growing.

References

- Ardichvili, A., Jondle, D., & Kowske, B. (2012). Minding the gap: exploring differences in perceptions of ethical business cultures among executives, mid-level managers and non-managers. *Human Resource Development International*, 15(3), 337–352. <https://doi.org/10.1080/13678868.2012.687625>
- Aspromourgos, T. (2024). Maximizing profits versus maximizing revenue: a note on Adam Smith's invisible hand. *Review of Political Economy*, 1–8. <https://doi.org/10.1080/09538259.2024.2431499>
- Bank of Lithuania. (2025). *Statistics database*. <https://www.lb.lt/en/statistics-database>
- Barber, K., Kopf, D.A., & Peltier, J. W. (2023). The effects of profit-maximization on ethical climate in higher education: a qualitative study utilizing neutralization theory. *Journal of Marketing for Higher Education*, 1–20. <https://doi.org/10.1080/08841241.2023.2219225>
- Beck, K. (2023). Synchronization without similarity. The effects of COVID-19 pandemic on GDP growth and inflation in the Eurozone. *Applied Economics Letters*, 30(8), 1028–1032. <https://doi.org/10.1080/13504851.2022.2032579>
- Błoński, K., & Witek, J. (2019). Minimalism in consumption. *Annales Universitatis Mariae Curie-Skłodowska, sectio H – Oeconomia*, 53(2), 7–15. <https://doi.org/10.17951/h.2019.53.2.7-15>
- Brewster, C., & Bennett C.V. (2010). Perceptions of business cultures in eastern Europe and their implications for international HRM. *The International Journal of Human Resource Management*, 21(14), 2568–2588. <https://doi.org/10.1080/09585192.2010.523575>
- Chen, K., & Kim, J. (2024). Effects of supply chain bottlenecks and fiscal stimulus on inflation dynamics in the COVID-19 pandemic era: A case of South Korea. *Applied Economics*, 1–14. <https://doi.org/10.1080/00036846.2024.2385750>
- Chin, T., Jin, J., Wang, S., Caputo, F., & Rowley, C. (2023). Cross-cultural legitimacy for orchestrating ecosystem-based business models in China: A Yin-Yang dialectical systems view. *Asia Pacific Business Review*, 1–24. <https://doi.org/10.1080/13602381.2023.2290263>
- Eurostat. (2025). *Economy and finance*. <https://ec.europa.eu/eurostat/web/main/data/database>
- Fritsch, S. (2023). Adam Smith, just commercial society and corporate social responsibility. *Review of International Political Economy*, 30(4), 1582–1604. <https://doi.org/10.1080/09692290.2022.2127832>
- Gallo, E., & Rochon, L.P. (2024). Sellers' inflation and distributive conflict: Lessons from the post-COVID recovery. *Review of Political Economy*, 36(4), 1331–1350. <https://doi.org/10.1080/09538259.2024.2358130>
- Grachev, M., & Izyumov, A. (2004). Development of business culture in a newly market economy. *Journal of East-West Business*, 9(2), 7–28. https://doi.org/10.1300/J097v09n02_02
- Hong, Y., Jiang, F., Meng, L., & Xue, B. (2025). Forecasting inflation using economic narratives. *Journal of Business & Economic Statistics*, 43(1), 216–231. <https://doi.org/10.1080/07350015.2024.2347619>
- Kozarzewski, P., & Bałtowski, M. (2022). State capitalism in Poland. *Annales Universitatis Mariae Curie-Skłodowska, sectio H – Oeconomia*, 56(1), 61–77. <https://doi.org/10.17951/h.2022.56.1.61-77>

- Lear, W.V. (2024). An assessment of pandemic era inflation, 2021 – 2022. *International Journal of Political Economy*, 53(2), 149–163. <https://doi.org/10.1080/08911916.2023.2278813>
- Matamoros, G. (2024). Are firm markups boosting inflation? A post-Keynesian institutionalist approach to markup inflation in select industrialized countries. *Review of Political Economy*, 36(3), 1042–1063. <https://doi.org/10.1080/09538259.2023.2244440>
- Oh, I., Fei, L., & Andrews, T.G. (2024). Understanding the dynamics of national business culture: A stationarity analysis for the case of South Korea. *Asia Pacific Business Review*, 1–27. <https://doi.org/10.1080/13602381.2024.2389259>
- Prabheesh, K.P., Affandi, Y., Gunadi, I., & Kumar, S. (2024). Impact of public debt, cashless transactions on inflation in emerging market economies: Evidence from the COVID-19 period. *Emerging Markets Finance and Trade*, 60(3), 557–575. <https://doi.org/10.1080/1540496X.2023.2228463>
- Shaw, P. (2024). Reading consumers' minds: an analysis of inflation expectations. *Macroeconomics and Finance in Emerging Market Economies*, 1–28. <https://doi.org/10.1080/17520843.2024.2352955>
- Statistics Lithuania. (2025). *Database*. <https://osp.stat.gov.lt/statistiniu-rodikliu-analize/#/>
- Yan, T., Hyman, M.R., Aguirre, G.C., & Zhou, W. (2024). A synthetic model of Chinese business ethics in business-to-business contexts. *Journal of Business-to-Business Marketing*, 31(1), 67–86. <https://doi.org/10.1080/1051712X.2024.2315337>
- Zapletalová, Š. (2023). The business excellence models and business strategy. *Total Quality Management & Business Excellence*, 34(1–2), 131–147. <https://doi.org/10.1080/14783363.2022.2033615>
- Zhang, W., Jiang, X., Wen, M., & Su, X. (2024). Business strategy aggressiveness and firm innovation: Evidence from listed companies in China. *Applied Economics*, 1–16. <https://doi.org/10.1080/00036846.2024.2342063>
- Zurkinden, L. (2022). Organizational culture: A tool for bridging the design-implementation gap of sustainable business model innovation. *Journal of the International Council for Small Business*, 3(3), 246–254. <https://doi.org/10.1080/26437015.2021.1989636>