



SATVAL - Monte Carlo computer code for windows system

Juliusz Sielanko*, Marcin Smolira

*Institute of Physics, Maria Curie-Skłodowska University,
Pl. M.Curie-Skłodowskiej 1, 20-031 Lublin, Poland*

Abstract

SATVAL is the Monte Carlo computer code which calculates both the final 3D distribution of the ions irradiating the solid target and kinetic phenomena associated with the ion energy loss like sputtering, cascade mixing effect and so on. All atom cascades in the target are followed in detail including the dynamical change of composition of the irradiated sample layers.

The code was developed in the Institute of Physics of the Maria Curie-Skłodowska University in Lublin [1-3] and permanently modified for the increase of its calculations possibilities of the phenomena[4-5].

1. Scientific background to SATVAL

1.1. Physics of recoil cascades

For the calculation purpose of cascades in target ions, in the program certain assumptions are made. Let us assume that an incident atom has the atomic number Z_1 , and the energy E and collided with the target atom of atomic number Z_2 . After the collision, the incident ion has the energy E_1 and the hit atom has the energy E_2 . Specified for the target atoms the energies E_d - the displacement energy, E_b - the binding energy of a lattice atom to its site, and E_f - the energy of a moving atom after collision, below which it is considered to be stopped we assume that a displacement occurs if $E_2 > E_d$ (the hit atom is given enough energy to leave the site). A vacancy occurs if both $E_1 > E_d$ and $E_2 > E_d$ (both atoms have enough energy to leave the site). If a cascade atom leaves the target volume or rear surface – determined by the target thickness, it is no longer followed and discarded. The program follows the atom until its energy falls below E_f .

1.2. Implantation

The simulation of slowing down energetic ions in solids allows the rigorous treatment of the depth profiles of implanted ions giving all required higher

* Corresponding author: e-mail address: jzs@tytan.umcs.lublin.pl

moments of the concentration distribution curve. The nuclear energy loss in a single collision is calculated from the scattering angle evaluation, the last one is obtained from the classical scattering integral for the same interatomic potential. The electronic energy loss calculation method can be chosen in the code between the Lindhard-Scharff [6] or Oen Robinson [7] model.

1.3. Sputtering

Sputtering occurs when the near-surface atoms is removed from the target. When a cascade gives a target atom an energy greater than the surface binding energy E_s of that target, the atom may be sputtered. The E_s energy is known only for a few materials, but it is common to use the heat of sublimation instead. To be actually sputtered, the atom's energy normal to the surface must still be above the surface binding energy when it crosses the plane of the surface. The sputtering of a material is described by a sputtering yield, which is defined as the mean number of sputtered target atoms per incident ion.

2. New calculation feature in 1.27 version of the code

2.1. Variation of the E_s and E_d energies with a dose of irradiation

In the new version of the program optionally, the linear variation of energies E_s and E_d with the implantation dose was introduced. In this case in every iteration step, the values of these energies are estimated from the equations:

$$E_s(d) = E_s^0 - k_s(d - d_s),$$

$$E_d(d) = E_d^0 - k_d(d - d_s),$$

where

$$k_s = \frac{\Delta E_s}{\Delta d},$$

$$k_d = \frac{\Delta E_d}{\Delta d},$$

$$\Delta d = d_e - d_s,$$

$$\Delta E_s = E_s^0 - E_s^e,$$

$$\Delta E_d = E_d^0 - E_d^e,$$

E_s^0 – is the surface binding energy of a pure target,

E_s^e – is the surface binding energy of implanted target with the dose d ,

E_d^0 – is the displacement energy E_d of an atom in a virgin target,

E_d^e – is the E_d energy for the target implanted with the dose d ,

d_s, d_e – are the doses range, for which the E_s and E_d energies may decrease linearly.

The user may also choose the second option of the calculation of surface energy variation with the increasing dose of irradiation. The target composition during the irradiation is changed and results in the density variation of implanted layers. In the code such a phenomenon is taken into account by the reciprocal addition of the atomic densities of pure elements according to the composition. The update of depth distribution of implants and then the density of the target is done after each bombarded ion and recoil cascade has come to rest. The dynamic change of surface binding energy E_s during the increase of the dose of implanted ions is introduced in the code by means of interpolation of the E_s values of the pure components according to the composition of the surface layer.

2.2. Calculation of the angular distribution of sputtered atoms

The new version of the code gives the possibility of calculation of the angular distribution of sputtered atoms. In this case the number of sputtered atoms (intensity) is printed as a function of angles θ and α – see Fig. 1. An example of such distribution is shown in Fig. 2. where contour plots (lines of equal intensity) of the angular dependence of Ti sputtered particles for the 1500eV Nitrogen bombardment of Ti under the 80° angle of irradiation are drawn.

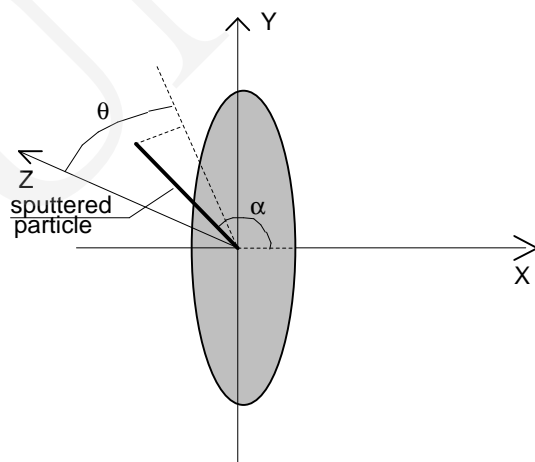

Fig. 1. Angles α and θ . These angles and number of sputtered atoms are printed as a table in SATVAL.ROZ file

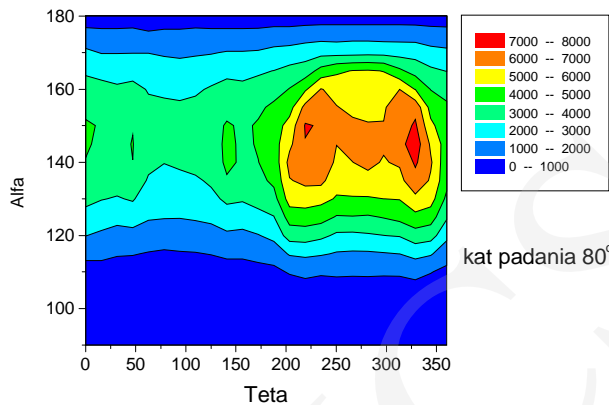

Fig. 2. Contour plots (lines of equal intensity) of the angular distribution of sputtered particles for N->Ti (1500eV) and angle of incident $\phi=80^{\circ}$

3. Using SATVAL program

SATVAL ver 1.7 is adopted for the use in the Microsoft Windows systems (95, 98, XP) and consists of two main programs, and several special-purpose files. SATVAL for the Windows operating system is more user-friendly than a DOS version of this program. A text file, which a user must edit mark by mark, is replaced by a window with data fields (see Fig.3). The only thing that the user has to do is filling up these fields with proper data. The new version helps to prepare and manage all input data files, but to make calculations, it uses the DOS version of Satval execution file.

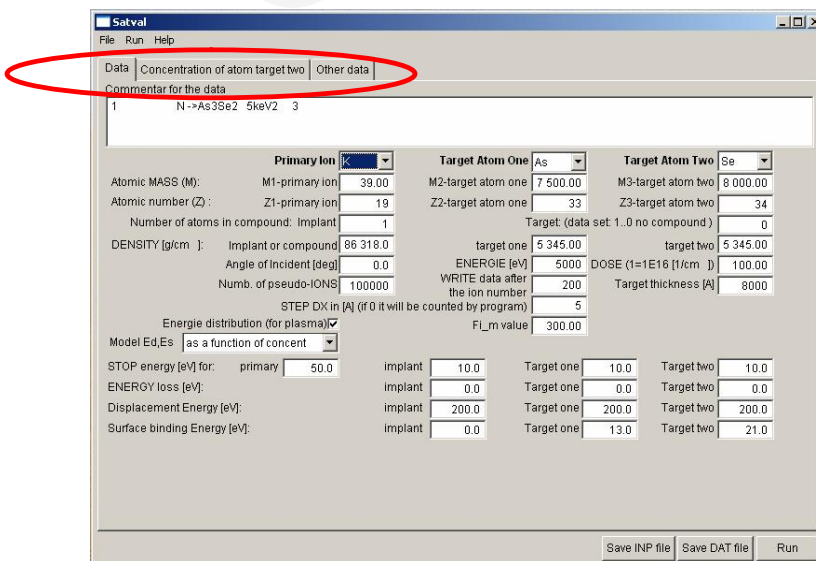

Fig. 3. The main SATVAL window of three groups of data

The input data are separated into three groups (figure 3):

- data;
- concentration of atom target two;
- other data.

Such separation is the result of input data files structure. The first group DATA (just opened in Fig. 3) contains fundamental parameters, which may be chosen by the user such as: a kind of bombarded ions, target atoms (may be a two atom compound), density of target, dose of irradiation, energy of primary ion beam, and others. The second group contains the data relating to a dopand (compounds) concentration distribution. The last group includes additional input data required by the SATVAL code, and may be chosen by the user. After starting the program fields are filled up with recently used input data. These data are automatically saved just after starting calculation. The user can change every parameter of a simulation. Specially configured masks for each field restrict probability of an error during editing the data.

Drop down list of atom symbols is an additional facility of the SATVAL program for windows. Data in the fields like mass or atomic number, adequate for the selected atom, change after changing an element. The program menu reacts on the chosen option of the simulation like the model of E_s and E_d variation with the increasing dose of irradiation, and according to the change of the model adapts a view of the window (figure 4).

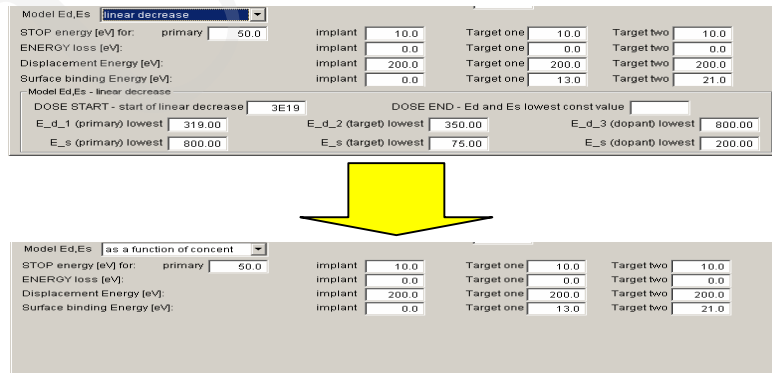

Fig. 4. A change of the window view as a result of the chosen simulation model

The second window data Concentration of target (2) may be used for determining the concentration of the second target atom in the compound or concentration of impurity atoms, dopands or thin film layers. Up to 50 layers may be determined by the user in this data set – see Fig.5.

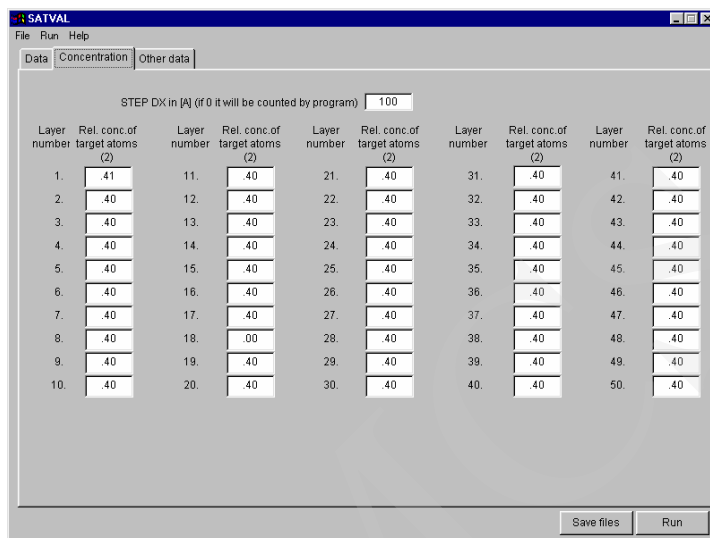

Fig. 5. Relative concentration distribution of secondary target atom in the compound, or as an impurity concentration (dopant atoms), or thin film layers deposited on the substrate

The third window input data named Other data contain specific parameters which enable the user to choose some theoretical models used by the code in the simulation process. For an example model of the electronic stopping power (LSS or Oen), interatomic potential (Universal [8] or Molier [9,10]), surface barrier model (planar or isotropic) and so on – see Fig 6.

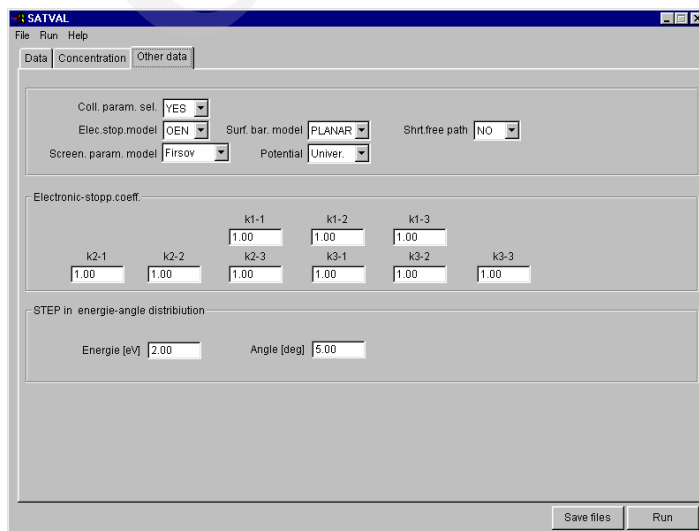

Fig. 6. The window input data Other data giving the possibility to choose various theoretical Models.

Extensions of Satval input data files are INP and DAT. Each created file has one of these extensions automatically. When the user wants to open the file, the SATVAL for windows system shows a list of existing files. Compared with the DOS version of the code, there is no restriction to names of file in the SATVAL for windows, it accepts every name. The program opens a selected file and fills up the fields with proper data. When simulation is started the code saves data from windows fields to the input data files 'satval.INP' and 'satval.DAT'. As the results of the calculations the program produced 3 files SATVAL.VIP, SATVAL.ROZ and SATVAL.CON. The last one is the file in which all data necessary for the restart of the program are stored. This file is used when the user breaks the calculation and wants to restart the program later on to prolongate its run. In the SATVAL.VIP file all calculated results are succesively stored during the run of the program. The user may find there the depth distribution of implanted atoms, the mean projected range and strugglinig of the concentration distribution curve, sputtering yield of each elements (target, or implanted primaries), retained dose, angle and energy distribution of sputtered particles, number of reflection ions, surface etching rate vs. the dose of irradiation and so on. In SATVAL.ROZ file the table of the angular distribution mentioned above of sputterd particles is stored.

There is help in the menu that allows to get to know the program and all kinds of parameters used in the program – see Fig. 7.

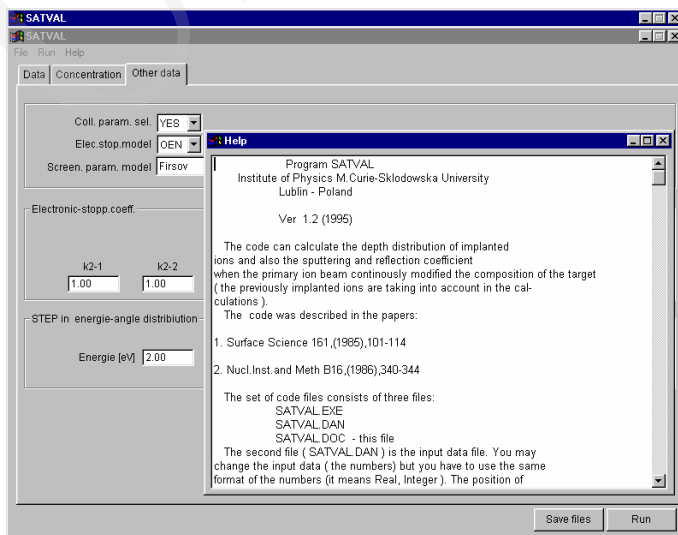

Fig. 7. In the HELP menu the user may find detailed description of the SATVAL code and definition of all parameters used in the program

Conclusions

The SATVAL for windows is made as the user friendly code. It creates specially formatted input data files, which in the earlier DOS version the user had to edit in some text editor having paid attention to a number of lines, spaces, etc. The additional facility are fields masks. The user is sure that each datum has correct syntax in the created file. The next user-friendly function is a possibility of profit by any name of files. It allows to store all the needed files in one catalog without the necessity to rename it before the use. Owing to this, the time needed to prepare all data for simulation is short. In spite of all changes described, preciseness of calculations using the SATVAL for windows program is not worth then preciseness of Satval for DOS calculations. This is because it uses the execution file of Satval for DOS.

References

- [1] Sielanko J., Szyszko W., Surface Science, 161 (1985) 101.
- [2] Sielanko J., Szyszko W., Nucl.Instr.and Meth., B16 (1986) 340.
- [3] Szyszko W., Sielanko J., Phys.Stat.Sol. (A), 112 (1989) 315.
- [4] Sielanko J., Hereć J., Elektronika, 7 (2001) 29.
- [5] Sielanko J., Hereć J., to be published in Vacuum.
- [6] Lindhard J., Scharff M., Phys.Rev, 124 (1961) 128.
- [7] Oen O.S., Robinson M.T., Nucl. Instr. and Meth., 132 (1976) 647.
- [8] Biersack J.P., Ziegler J.F., in: Ion Implantation Techniques, Ed. H. Ryssel and H.Glawisching, Springer Ser. Electrophys., 10 (1982) 122.
- [9] Molière G., Z. Naturforsch., A2 (1947) 135.
- [10] Sielanko J., Rad.Eff.Lett., 86 (1984) 185.